

AXESS 2 LTD

# TRACTION MRL 450kg

INFORMATION AND GUIDANCE PRE/POST INSTALLATION

- P2-5** Stage 1 - Pre-Installation notes  
Lift shaft and door entrances
- P5** Site Surveys
- P6** Safety at Work
- P7-8** Electrical Provisions
- P8** Access – Scaffold and Planking
- P9** Stage 2 - Post Installation
- P10** Primary Notes

## Stage 1 - Pre-Installation notes

### LIFT SHAFT AND DOOR ENTRANCES



The following works are to be completed before our lift installation can commence and should be read in conjunction with our quote and general arrangement drawings. It is extremely important that the lift shaft maintains the correct measurements for its entirety and is plumb and square.



Our installers will use plumb lines and lasers mainly down the guide rail fixing wall, and take all measurements from the tightest point in the lift shaft, this is the DATUM that they work to, if at this point they are 30mm out from top to bottom you have lost 30mm from the measurements we show on our drawings and your lift cannot be installed. Most problems we encounter are caused because of this, and although you may have the correct measurements in all of the lift shaft if the walls are not straight and plumb for the full length of the lift shaft, we will encounter problems.



A Loadings Plan is indicated on page 3 our GA drawings and bracket positions on page 4, you should always seek professional advice from a structural engineer regarding loadings and construction of the lift shaft and pit. We only need support walls where there are guide rail fixings as shown on the GA, if the other walls are not required for load bearing check strength of walls with the table below. Axess 2 can provide a full steel frame if required see further notes.



We will require, and seek confirmation that the shaft walls and pit floor, can support our equipment, and the confirmation of the correct material has been utilised for fixing of the guide rails and landing doors. All guide rail positions and door fixings are shown on page 2 of our GA drawings. All loadings provided are dynamic loads that have been factored, with full load in the lift car and a safety gear activation.



Strength of all walls and door side returns will need to be as required by BS EN 81-20 as below.

- The walls of the **lift shaft** shall have a mechanical strength such that when a force of 1000 N, being evenly distributed over an area of 0,30 m x 0,30 m in round or square section, is applied at right angles to the wall at any point on either face they shall resist without:
  - permanent deformation greater than 1 mm;
  - elastic deformation greater than 15 mm.
- Glass panels, plain or formed shall be made of laminated glass.
- They and their fixings shall withstand 1000 N horizontal static force on an area of 0,30 m x 0,30 m at any point, from both inside and outside the well, without permanent deformation.



**NOTE: It is important to notify Axess 2 Ltd, if there is a room below the lift pit, as a traction lift cannot be used without safety gear on the counterweight (some models do not have this feature available and we may have to change to type of lift accordingly)**

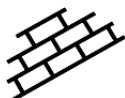

Provide a fully completed enclosed lift shaft in accordance with the dimensions and loadings provided, for the entirety that the lift is to travel and including the pit and headroom. The lift shaft should be plumb and square (tolerance +100 mm, -0 mm) all perfectly in line with all other floors and the pit. Close the top of the lift shaft with a fire rated approved material and install a smoke detector. A 500kg lifting hook is required for this product.



Provide a pit at the lowest floor to the dimensions shown on page 1 of GA drawing, (tolerance +100 mm, -0 mm on width, depth and +0/-0 on height), ensuring a flat, level and dry base on which the lift equipment is to sit. This dimension is taken from the finished floor dimension.



The lift shaft should be painted with a dust preventing paint, emulsion or PVA sealer and primer mix is suitable, the pit floor should be painted with an oil resistant paint.



It is imperative that the lift shaft is dry and has no possibility of water entering the lift shaft or lift pit for the life duration of the installation. Water will cause serious damage to any lift components and electrical equipment. Seek advice for solutions from your builder or consultants.



Do not build any returns to either side of the landing doors at this stage, leave the full width opening to the specified height from the final finished floor to lintel (2280mm for sliding doors or 2140mm for swing doors without automatic opener, with automatic opener + 40mm -2180). It is important to allow for any floor finishes when setting the height of your door entrance lintel.

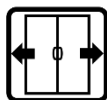

All lift entrances must have the floor and lintel completed to the lift shaft which provide fixing for the doors (see fig 1), there must not be any obstructions in the floor e.g: (underfloor heating pipes, cables etc) (see fig 1.1) and the lintel should be in place at the correct height, shown on our GA drawing and according to door fixing loads.

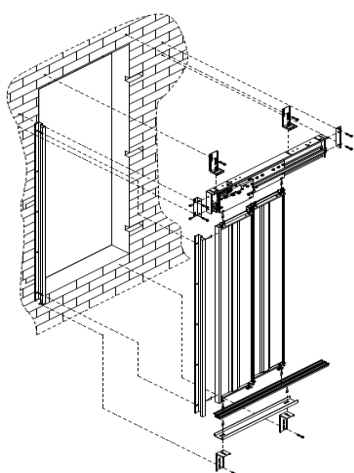

**Fig.1**

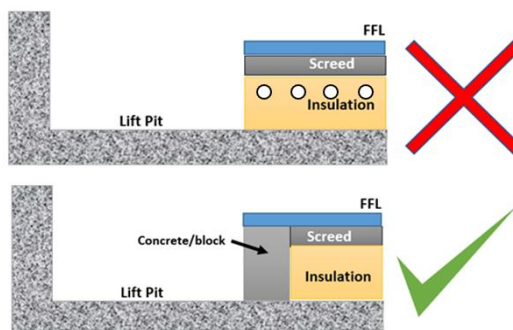

**Fig.1.1**



A datum line should be clearly marked at 1000mm above each FFL where the landing sill or door threshold is to be positioned, this should take into account final floor finishes.



**All lintels and floors must be in line for the entire lift shaft, check alignment with a plumb line (see fig 2)**

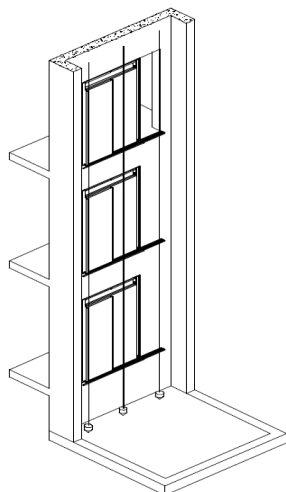

**Fig.2**



The lift shaft and doors may have to comply with Local Authority Fire Regulations, and we recommend that you contact them for any requirements or seek professional advice. Please check your drawings as we will only supply fire rated doors if requested. When building the returns after the doors are installed please ensure the fire rating material is used.



Your lift may need to comply with DDA requirements if in a commercial or retail premises, visit able dwellings, accessible dwellings, wheelchair user dwellings. All lifts in our range may have this option but will only be included if requested. Please seek advice from your consultant and building control. There are also elements of the DDA that apply to and not exhaustively, the turning circle outside the lift cabin and lighting arrangements at each floor level, reference can be made to part M on the following link

<https://www.gov.uk/government/publications/access-to-and-use-of-buildings-approved-document-m>

**Lifts for private dwellings do not need to comply.**



If a steel frame is included or may be required, ensure all apertures are in line with the pit and that lateral support is available, the frame supplied by Axess 2 Ltd is mostly freestanding and all loads are factored into the design of the frame, the structure needs fixing to the building at 4 points in the pit, every floor level on at least 2 corners on the uprights and at 2 points at the top of the lift shaft (see fig 3). Allow for a drilled rawl bolt / chemical resin / steel beam fixing. There is only a low pull out load on the lateral fixing (see fig 3.1)

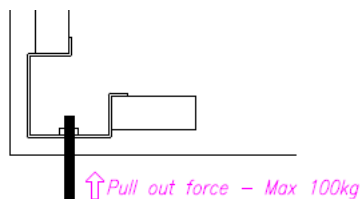

**Fig 3.1**

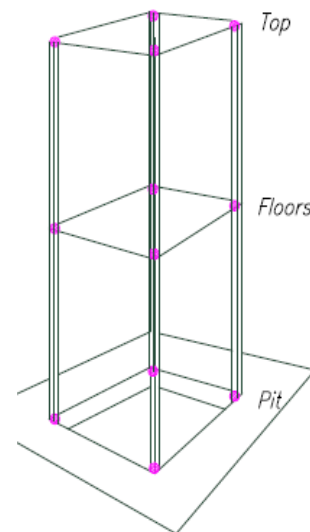

**Fig 3**



A 100mm flexi hose duct / hole with a drawstring, should be provided from the lift shaft, and routed to the location agreed for the lift control cabinet if the remote cabinet option has been chosen, this is for the control cables and shaft wiring. Check with the building designer for the location of the cabinet and must be at the top floor.

The position of the cabinet must be within 4mts of the lift shaft and have the designated space as shown on our GA drawings, for safe working. The area must be well ventilated with a temperature range of 5 – 36 degrees min – max.

**IMPORTANT - If the above items have not been completed, we will be unable to test the lift or affix the CE Mark. Any additional return visits will be charged.**

## SITE SURVEYS AND VISITS



We offer a site survey and a report free of charge to prevent any errors and make sure the above are clarified. You must request this from Axess 2 Ltd, preferably 4 weeks prior to the installation.















If we abort a visit due to major items not being completed or any health and safety risks, we will have to re-book into our installation programme which could be up to an 8 weeks delay.



An abortive visit charge would be incurred with all associated costs to be added for further storage and delivery.

## REQUIREMENTS FOR SAFE WORKING

- 1  You will need to provide an adequate dry storage area 4mts x 5mts, near to the lift shaft, for the distribution of our lift materials and tools on site, for the duration of the installation.
  - 2  A full height barrier should be secured in place at each landing entrance with warning notices 'NO ENTRY DO NOT REMOVE'. There are companies that now provide this service if required.
  - 3  Enable safe and secure access to the lift shaft, e.g. scaffold, stairs and boarded floors, to each level of the building that the lift is to serve. A drawing is supplied by Axess 2 on the arrangement required.  
  
**It is very important that the scaffold is tagged and inspected and is available on the first day of the installation, follow the instructions on our drawing. We also have a planking system that we can loan to you, which we have special brackets that are certified to do this and clear instructions.**
  - 4  Provide skip for waste removal. We aspire to generate minimal waste and such, our manufacturers only pack our equipment, with enough materials to guarantee their delivery to site without damage. Our engineers will clear away empty wooden packing cases and rubbish on a daily basis from our work area to a skip or rubbish point provided by others.
  - 5  Our engineers are required to work in a clean and tidy environment and will keep their own work area clean for safety and good housekeeping.
  - 6  We must be notified of any asbestos related issues and shown the register.
  - 7  No other trades should be working around any lift door entrances or at the ground floor door at any time during the lift installation.
  - 8  Welfare facilities as a minimum, clean toilet, washing facilities, hand drying, clean rest area and facility to warm food.
  - 9  Parking space for loading and unloading tools and equipment from company vehicles.
  - 10  Task Lighting at every door entrance and all working areas
  - 11  Please advise if there are any offloading facilities for the delivery or we will arrange HIAB delivery
-  **IMPORTANT** - If any of the items listed are not in place, it is not safe for us to begin the installation of the lift, in accordance with HSE and our OHSAS 18001 policy.



## ELECTRICAL PROVISIONS – TRACTION 1000kg



415V – 3 phase + neutral power supply and earth. The power must be LIVE on the first day of the installation. Not having power on our arrival will cause delays on the installation as we use the platform of the lift to install the lift.



**If the permanent isolator is not available at the time of the installation and we are unable to route our mains cable prior to the cladding (enclosure) work, the contractor must arrange to route our mains cable to the isolator position to avoid possible problems with final finishes at commission stage.**



A consumer unit with the following, 3 phase 30-amp motor rated MCB lift supply 1 x 6amp MCB power socket in pit, 1 x 6 amp shaft lighting. Positioned at the side of the controller for the lift and accessible. The main power switch must be lockable.



This should be located at the agreed position of the electrical cabinet, 2mts from the floor and should always be accessible and not above ceilings or behind walls. Please consult building designer for location of the cabinet.



Motor rated current 17.8 amps  
Starting current 26.7 amps, 8.2 kW.  
Gearless Motor with VVVF Gefran driver.



Provide an 110V power supply for tools, adjacent to the lift for the duration of the installation work.



A PTSN dedicated telephone line is required for the auto dialler, terminating to a BT standard socket at the same position as the power supply isolator. If a phone supply is not possible, we can install a GSM with an open sim card for 2 years (providing network coverage is possible) at extra cost.



**By law, the lift cannot be activated without the telephone line being live**



A smoke detector is required to be mounted on the ceiling of the lift shaft, a No volt normally open fire connection linked to the fire alarm should be positioned with the electrical isolator and the telephone line at the cabinet position. This signal will return the lift to a designated floor on activation of the fire alarm and park the lift with the doors open until the command is released.

## ELECTRICAL PROVISIONS cont...



An emergency light with battery backup should be located at the cabinet position to give a minimum of 200 lux at the floor level everywhere the person needs to work at the control cabinet and 50 lux at floor level to move between work areas. Natural or artificial lighting should be at least 50 lux at floor level in the vicinity of all landing doors, so the user can see ahead even if the cabin light has failed. For a domestic property this is not mandatory but advisable.



All of our lifts have some kind of UPS or battery backup and require the power to be permanently on to the lift once we have commissioned the lift, if the power is removed the batteries or UPS must be disconnected.



Shaft lighting needs to be installed and is mandatory, a continuous IP65, 240-volt LED strip, 10 watts per metre, for the full length of the lift shaft this should be securely clipped to the opposite wall to the guide rails in the centre of the lift shaft. There should be an isolator switch at the consumer unit. The supply for the LED strip should be at the top in a termination box. Our engineers will fit a pull cord switch and connect a supply from the isolator you have provided. If the shaft light is not installed Axess 2 will install the lighting at extra cost.

## ACCESS - SCAFFOLDING OR PLANKING

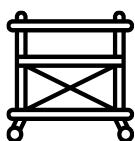

Scaffold or planking is required. If either of these are not available at the time of installation, Axess 2 can provide the scaffold at extra cost. Please advise if you would like us to arrange.

If supplied by others, all scaffolding, planks and ladders etc. are to be fixed and secured to the lift installers satisfaction. This scaffolding should fully comply with the latest British Standards and HSE guidelines.

All Axess 2 installation teams are PASMA certified. We use a special Spanset fall arrest and harness system. All teams are fully trained in rescue operations. Scaffolding should be cleaned down and free of all other trades.

### OPTION A (preferred)

Plank method

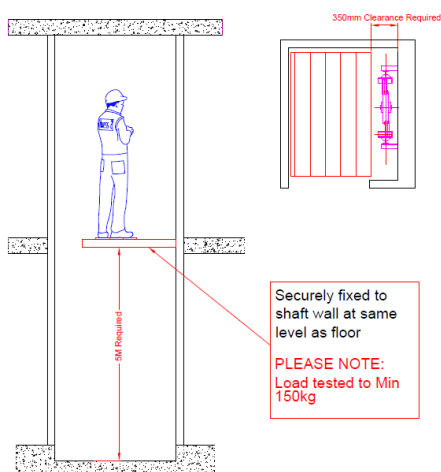

### OPTION B

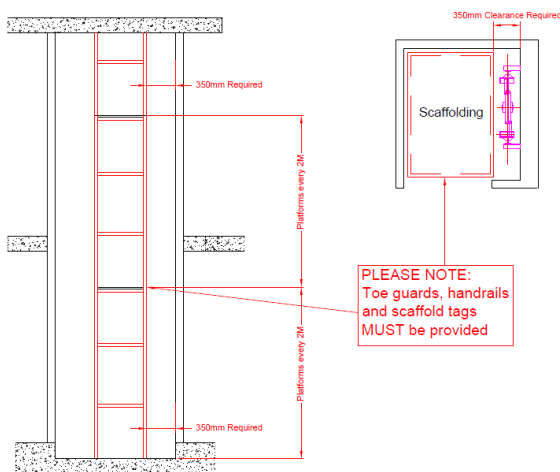

Scaffolding method









## Stage 2 – Post Installation

The lift must be correctly enclosed to comply with the requirements of lift standards and building regulations.

- 1  After the lift has been installed, the builder is to complete the enclosure / cladding around the lift shaft and make good ensure to follow the instructions for the strength of walls information
- 2  Please fill in any gaps between the existing floor and door sills with no tripping hazard.
- 3  Ensure the permanent power supply is live and the tail cable has been routed to our control panel as specified.

 **IMPORTANT-** take care to avoid damage of the lift equipment (including cables) nothing should be screwed or fixed to our doors or lift shaft / structure without written permission. The lift equipment is to be shielded from any damage, plaster, paint, debris or water ingress whilst carrying out your works and until the lift is commissioned.
- 4  Provide and fit adequate protection to all exposed lift parts and doors external to the lift shaft.
- 5  Permanent notices reading DANGER - LIFT MACHINERY, UNAUTHORISED ACCESS PROHIBITED - DOOR TO BE KEPT LOCKED will be fitted on the outside of the motor compartment door to comply with current safety regulations. Our engineer will fit these notices when he returns to test and commission the lift only.
- 6  Clean the lift shaft exterior components, glass or any other exposed equipment to remove all building dust, paint, rubble and waste matter not made by us. Axess 2 Ltd will not accept liability for any damage caused through negligence or non-compliance with these requirements.
- 7  The protective covers will be left on the lift doors and lift cabin if the site is not ready for handover after completion of installation, and will be left in such a way that the protective material will peel easily from corners and will be pre-cut. Axess 2 will charge an extra fee to remove and clean down the doors and remove covering after you have received the lift complete certificate. If the lift is a glass structure the clean down is the responsibility of the contractor or we can provide this service from a professional cleaning company at extra cost.

## PRIMARY NOTES



The drawings and notes provided, have been prepared on the information provided to us and has generated the technical specification from the quotation and terms and conditions, please check carefully and consult your building designer, fire officer, consultants as to the specification given.



Any changes to the site details, specifications, finishes and dimensions will affect the cost and installation, and **MUST** be communicated to Axess 2 Ltd in writing, who will provide revised drawings and costs.



A site survey by a representative of Axess 2 Ltd, does not negate any responsibility from the contractor to ensure that the shaft and all ancillary works and requirements, are a true reflection of the drawing and notes in the quote and these instructions.



**ITEMS WE MAY NOT BE ABLE TO CHECK IF THERE IS NO SCAFFOLD IN THE LIFT SHAFT OR ROOMS ARE NOT ACCESSIBLE OR BUILT, AT THE TIME OF THE FREE REQUESTED SURVEY.**

- i) Squareness and Plumbness of the shaft.
- ii) Load bearing capacity of the lift shaft support wall.
- iii) Motor room positioning must always be confirmed on the sign off drawings.
- iv) We can check the travel of the lift, but if the sizes differ from the approval drawings it will incur extra cost as the lift will be in production and will also delay the agreed installation date.

We can return for an extra survey at a cost of £295.00 if you would like us to check the above items should they not have been available at the time of our first survey. In accordance with EN81 regulations, no other services are to be installed within the lift shaft without the express permission of Axess 2 Ltd

## DON'T FORGET, WE'RE HERE TO HELP



**We know some of the items discussed here seem daunting and many people are building a lift shaft for the first time. Our objective is to be as informative as possible and as helpful as we can, and it is our utmost aim that you incur no extra charges, if you follow the notes carefully there should not be any problem. Please pick up the telephone if you are uncertain about anything, we have a dedicated projects team that will steer you through the complete installation start to finish. The very best way to communicate is to email, but you are welcome to call us too.**



[projects@axess2.co.uk](mailto:projects@axess2.co.uk)



01200 405005 (opt2)